

E-Spike™

Stainless Pigeon Spikes

E-Spike is the most affordable, all stainless steel bird spike ever made for **pigeons** and **seagulls**. When the budget dictates the job, you can't beat E-Spike's long lasting economy and value.



Affordable Quality

Economy spike with quality features. **All high grade stainless steel**, no plastic, 100% UV and flame proof, no assembly needed, ready to install.



Value and Versatility

E-Spike **covers up to 7"** of surface with a **single row**. The flexible base strip follows curves and can be quickly cut to length.

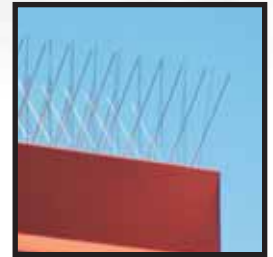

E-Spike Choices

Fasten with optional mounting hardware, glue clips and adhesive or just adhesive. **ColorCoat** colors and **Soft Tip** wires available.

E-Spike™ Models

All E-Spike models are all stainless steel, have a 1/4" flexible base strip and come in 24" and 48" lengths. E-Spike is designed as an economy stainless steel deterrent for **pigeons** and **seagulls only**. Do not use for small birds or heavy infestations of any bird. For control under all conditions, install the **Nixalite® Premium Bird Spike models**.

E-Spike Model 6405

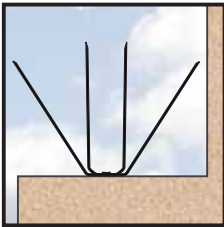

Standard model for all types of surfaces. Fasten with optional hardware or adhesive.

- All stainless steel
- 6" wide, 4" high, 48 points/ft
- Pointed or Soft Tip wires
- Available in ColorCoat colors

E-Spike Model 3405

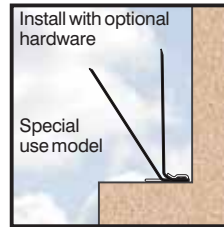

Special model for single exposed surfaces from 1 to 3" deep. Fasten with optional mounting hardware.

- All stainless steel
- 3" wide, 4" high, 24 points/ft
- Pointed or Soft Tip wires
- Available in ColorCoat colors

Estimating for E-Spike™

Basic Estimating Steps:

1. Measure surface **depth** and **length**.
2. Is surface **Single** or **Double Exposed**?
3. Use tables to find the **Rows Required**.
4. **Rows Required X Length = Total**.

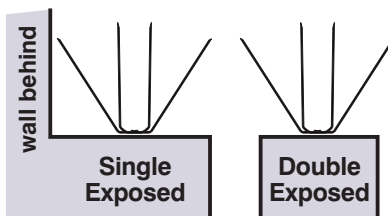

Single Exposed		
Surface Depth		Rows Required
Inches	Centimeters	
0 - 3	0 - 7.6	1/2*
3 - 7	7.6 - 17.8	1
7 - 14	17.8 - 35.6	2
14 - 21	35.6 - 53.3	3
21 - 28	53.3 - 71.1	4
28 - 35	71.1 - 88.9	5
35 - 42	88.9 - 106.7	6
For each additional 7" add 1 row		

Double Exposed		
Surface Depth		Rows Required
Inches	Centimeters	
0 - 6	0 - 15.2	1
6 - 13	15.2 - 33.0	2
13 - 20	33.0 - 50.8	3
20 - 27	50.8 - 68.6	4
27 - 34	68.6 - 86.4	5
34 - 41	86.4 - 104.1	6
41 - 48	104.1 - 121.9	7
For each additional 7" add 1 row		

*1/2 = E-Spike Model 3405

E-Spike™ Spacing

Model 6405

- A - 3" max. to edges
- B - 4" max. to walls
- C - 7" max. between

Model 3405

- D - 3" max. coverage

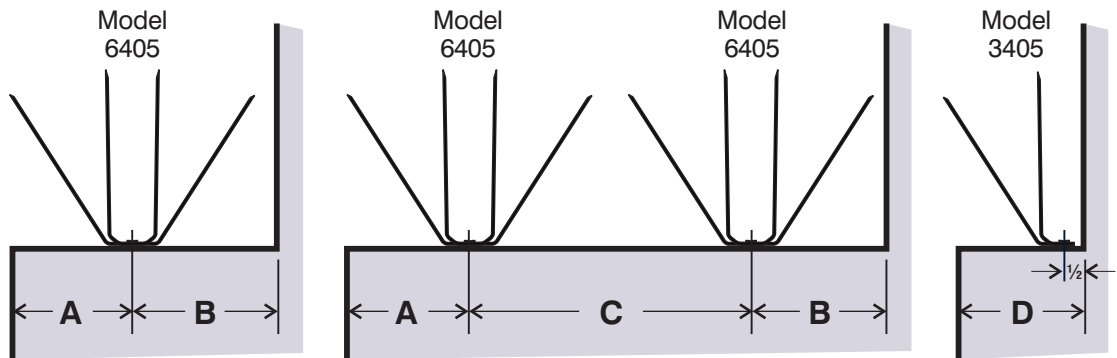

Installing E-Spike™

E-Spike is designed as an economy stainless steel deterrent for **pigeons** and **seagulls only**. Do not use for small birds or heavy infestations of any bird. For control under all conditions, install the **Nixalite® Premium Bird Spike models**.

Prepare the surface

Clean the surface thoroughly. It must be clean, dry and free of bird waste. Repair any damaged sections of the installation surface.

Lay out the spike strip positions

Use the **Estimating** and **Spacing** information to determine where on the surface each spike strip will be installed. Mark each spike strip location.

Fit the strip before fastening

Make sure each spike strip fits the surface properly before fastening it. **Follow these important details when installing:**

Make sure that the spike strips **overhang the ends of the surface at least 1/2"**.

Make sure the **tallest wire** is the **first** and **last** wire in any row of spike strips.

Do not allow gaps where two strips meet end-to-end **OR** where spike strips meet a wall or object.

Fastening E-Spike Strips

If fastening with adhesive, follow the adhesive manufacturer's application instructions printed on the adhesive container.

If installing with the optional hardware, contact Nixalite or view/print the hardware instructions at www.nixalite.com.

Make sure all spike strips are securely fastened to the installation surfaces.

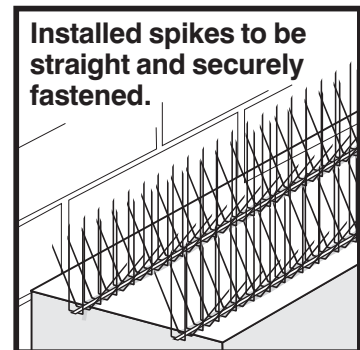
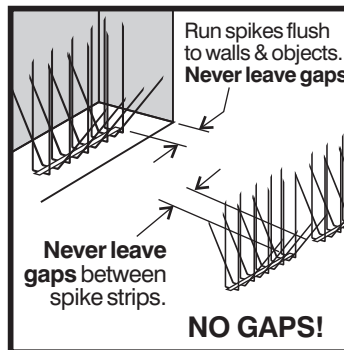
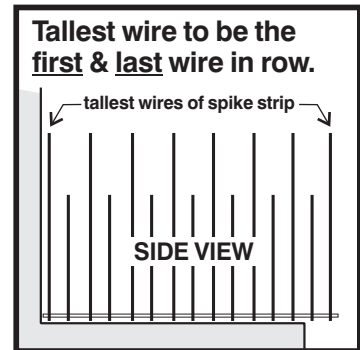
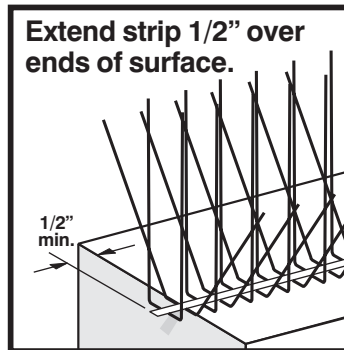

Nixalite® of America Inc.
 1025 16th Avenue East Moline, IL. 61244
 Experts In Architectural Bird Control Since 1950

Phone: 800.624.1189 or 309.755.8771
 Fax: 800.624.1196 or 309.755.0077
 Email: birdcontrol@nixalite.com
 Web: www.nixalite.com



Where the World Shops for Humane Bird and Animal Control.